

PRODUCT DESCRIPTION

ITEM

BL912, *9" Linen Shelf x 12 ft. (Bulk)*
CL912, *9" Linen Shelf x 12 ft. (Cartoned)*

(uses #8609 bracket)

BL1212, *12" Linen Shelf x 12 ft. (Bulk)*
CL1212, *12" Linen Shelf x 12 ft. (Cartoned)*

(uses #8012 or #8612 bracket)

BL1612, *16" Linen Shelf x 12 ft. (Bulk)*
CL1612, *16" Linen Shelf x 12 ft. (Cartoned)*

(uses #8016 or #8616 bracket)

BL2012, *20" Linen Shelf x 12 ft. (Bulk)*
CL2012, *20" Linen Shelf x 12 ft. (Cartoned)*

(uses #8020 or #8620 bracket)



DESCRIPTION

Linen (storage) shelf, 9" deep, 12 ft. long
Long wires: 4.5 gauge steel wire
Cross wires: 12.5 gauge steel wire,
resistant-welded on 1" centers
Front lip bent 1"
Coated with polyvinylchloride, 12-15 mil
PACKAGING: Steel Pallet - 204 pieces Maximum (Bulk)
Wood Pallet - 102 pieces Maximum (Bulk)
Cartoned - 6 pieces per carton

Linen (storage) shelf, 12" deep, 12 ft. long
Long wires: 4.5 gauge steel wire
Cross wires: 12.5 gauge steel wire,
resistant-welded on 1" centers
Front lip bent 1"
Coated with polyvinylchloride, 12-15 mils
PACKAGING: Steel Pallet - 204 pieces Maximum (Bulk)
Wood Pallet - 102 pieces Maximum (Bulk)
Cartoned - 6 pieces per carton

Linen (storage) shelf, 16" deep, 12 ft. long
Long wires: 4.5 gauge steel wire
Cross wires: 12.5 gauge steel wire,
resistant-welded on 1" centers
Front lip bent 1"
Coated with polyvinylchloride, 12-15 mils
PACKAGING: Steel Pallet - 150 pieces Maximum (Bulk)
Wood Pallet - 102 pieces Maximum (Bulk)
Cartoned - 6 pieces per carton

Linen (storage) shelf, 20" deep, 12 ft. long
Long wires: 4.5 gauge steel wire
Cross wires: 12.5 gauge steel wire,
resistant-welded on 1" centers
Front lip bent 1"
Coated with polyvinylchloride, 12-15 mils
PACKAGING: Steel Pallet - 102 pieces Maximum (Bulk)
Wood Pallet - 102 pieces Maximum (Bulk)
Cartoned - 6 pieces per carton

PRODUCT DESCRIPTION

ITEM

DESCRIPTION

BL912CM, *9" Linen x 12 ft. Close Mesh*
(Bulk)
CL912CM, *9" Linen x 12 ft. Close Mesh*
(Cartoned)

(uses #8609 bracket)

Linen (storage) shelf, 9" deep, 12 ft. long
Long wires: 4.5 gauge steel wire
Cross wires: 12.5 gauge steel wire,
resistant-welded on $\frac{5}{8}$ " centers
Front lip bent 1"
Coated with polyvinylchloride, 12 mils
PACKAGING: Steel Pallet - 204 pieces Maximum (Bulk)
Wood Pallet - 102 pieces Maximum (Bulk)
Cartoned - 6 pieces per carton

BL1212CM, *12" Linen x 12 ft. Close Mesh*
(Bulk)
CL1212CM, *12" Linen x 12 ft. Close Mesh*
(Cartoned)

(uses #8612 bracket)

Linen (storage) shelf 12" deep, 12 ft. long
Long wires: 4.5 gauge steel wire
Cross wires: 12.5 gauge steel wire,
resistant-welded on $\frac{5}{8}$ " centers
Front lip bent 1"
Coated with polyvinylchloride, 12 mils
PACKAGING: Steel Pallet - 204 pieces Maximum (Bulk)
Wood Pallet - 102 pieces Maximum (Bulk)
Cartoned - 6 pieces per carton

BL1612CM, *16" Linen x 12 ft. Close Mesh*
(Bulk)
CL1612CM, *16" Linen x 12 ft. Close Mesh*
(Cartoned)

(uses #8616 bracket)

Linen (storage) shelf 16" deep, 12 ft. long
Long wires: 4.5 gauge steel wire
Cross wires: 12.5 gauge steel wire,
resistant-welded on $\frac{5}{8}$ " centers
Front lip bent 1"
Coated with polyvinylchloride, 12 mils
PACKAGING: Steel Pallet - 150 pieces Maximum (Bulk)
Wood Pallet - 102 pieces Maximum (Bulk)
Cartoned - 6 pieces per carton

BL2012CM, *20" Linen x 12 ft. Close Mesh*
(Bulk)
CL2012CM, *20" Linen x 12 ft. Close Mesh*
(Cartoned)

(uses #8620 bracket)

Linen (storage) shelf 20" deep, 12 ft. long
Long wires: 4.5 gauge steel wire
Cross wires: 12.5 gauge steel wire,
resistant-welded on $\frac{5}{8}$ " centers
Front lip bent 1"
Coated with polyvinylchloride, 12 mils
PACKAGING: Steel Pallet - 102 pieces Maximum (Bulk)
Wood Pallet - 102 pieces Maximum (Bulk)
Cartoned - 6 pieces per carton

PRODUCT DESCRIPTION

ITEM

BR1212HB, 12" Rod Shelf High Bar x 12 ft.
(Bulk)

CR1212HB, 12" Rod Shelf High Bar x 12 ft.
(Cartoned)

(uses #8012 or #8612 bracket)

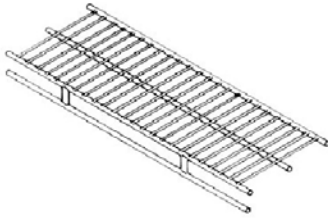

DESCRIPTION

Hanging rod (wardrobe) shelf, 12" deep, 12 ft. long

Long wires: 4.5 gauge steel wire

Cross wires: 12.5 gauge steel wire,
resistant-welded on 1" centers

Hanging rod: 1.5 gauge steel wire,

Resistant-welded spacers, 1¹/₄" hanging space

Coated with polyvinylchloride, 12-15 mils

PACKAGING: Steel Pallet - 102 pieces Maximum (Bulk)

Wood Pallet - 102 pieces Maximum (Bulk)

Cartoned - 6 pieces per carton

BR1612HB, 16" Rod Shelf High Bar x 12 ft.
(Bulk)

CR1612HB, 16" Rod Shelf High Bar x 12 ft.
(Cartoned)

(uses #8012 or #8612 bracket)

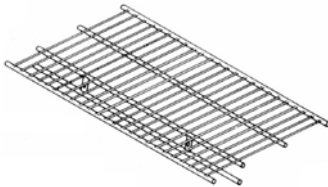

Hanging rod (wardrobe) shelf, 16" deep, 12 ft. long

Long wires: 4.5 gauge steel wire

Cross wires: 12.5 gauge steel wire,
resistant-welded on 1" centers

Hanging rod: 1.5 gauge steel wire,

resistant-welded spacers, 1¹/₄" hanging

space. Hanging rod is spaced 4" back

from front of shelf.

Coated with polyvinylchloride, 12-15 mils

PACKAGING: Steel Pallet - 100 pieces Maximum (Bulk)

Wood Pallet - 80 pieces Maximum (Bulk)

Cartoned - 6 pieces per carton

PRODUCT DESCRIPTION

BR1212EZ, 12" Easy-Glide Rod Shelf x 12 ft.
(Bulk)

CR1212EZ, 12" Easy-Glide Rod Shelf x 12 ft.
(Cartoned)

(uses #8612 bracket)



Continuous slide rod (wardrobe) shelf, 12" deep,
12 ft. long

Long wires, back & middle: 4.5 gauge steel wire

Long wire, front: 1.5 gauge steel wire

Cross wires: 12.5 gauge steel wire, resistant-welded
1" centers

Hanging brackets are stamped from 12 gauge sheet

Resistant welded to cross wire and hanging rod every
12 inches.

Hanging rod: 1.5 gauge steel wire

Coated with polyvinylchloride, 12-15 mils

BR1612EZ, 16" Easy-Glide Rod Shelf x 12 ft.
(Bulk)

CR1612EZ, 16" Easy-Glide Rod Shelf x 12 ft.
(Cartoned)

(uses #8612 bracket)

Continuous slide rod (wardrobe) shelf, 16" deep,
12 ft. long

Long wires, back & middle: 4.5 gauge steel wire

Long wire, front: 1.5 gauge steel wire

Cross wires: 12.5 gauge steel wire, resistant-welded
1" centers

Hanging brackets are stamped from 12 gauge sheet

Resistant welded to cross wire and hanging rod every
12 inches.

Hanging rod: 1.5 gauge steel wire

Hanging rod is spaced 4" back from front of shelf

Coated with polyvinylchloride, 12-15 mils

PRODUCT DESCRIPTION

BULK HARDWARE -- Support Brackets

ITEM

DESCRIPTION

8012

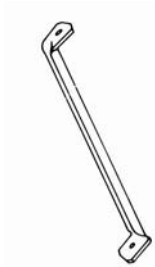

12" SUPPORT BRACKET. Main support of 12" Linen shelf, 12" Rod shelf, and 16" Rod shelf when installation is open end to open end, open end to wall or when shelf is over 3 feet long. Use one bracket for every 3 to 4 feet of shelving installed. Drill $\frac{7}{32}$ " hole for drywall or $\frac{1}{4}$ " for masonry.

Stamped from 16 gauge steel stock; coated with polyvinylchloride.

ACCESSORIES NEEDED: 2 - #8050 joiner plates (#8055 for high bar)

1 - #8100 screw

1 - #8200 anchor

1 - #8300 bolt

1 - #8400 hex nut

PACKAGING: Standard Carton - 100 pieces

8016

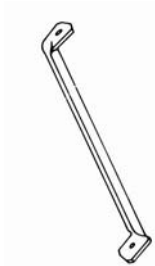

16" SUPPORT BRACKET. Main support of 16" Linen shelf when installation is open end to open end, open end to wall, or when shelf is over 3 feet long. Use one bracket for every 3 to 4 feet of shelving installed. Drill $\frac{7}{32}$ " hole for drywall or $\frac{1}{4}$ " for masonry.

Stamped from 16 gauge steel stock; coated with polyvinylchloride.

ACCESSORIES NEEDED: 2 - #8050 joiner plates

1 - #8100 screw

1 - #8200 anchor

1 - #8300 bolt

1 - #8400 hex nut

PACKAGING: Standard Carton - 100 pieces

8022



METAL CORNER BRACKET. Support in the corner when joining two shelves at a 45° angle to form "U" or "L" shape. Interweaves in the shelf to replace support bracket at the junction of two shelves.

Stamped from 12 gauge steel stock; coated with polyvinylchloride.

PACKAGING: Standard Carton - 100 pieces

8025



CLOSE MESH CORNER BRACKET. Made exclusively for Close Mesh Shelving.

Support in the corner when joining two shelves at a 45° angle to form "U" or "L" shape. Interweaves in the shelf to replace support bracket at the junction of two shelves.

Stamped from 12 gauge steel stock; coated with polyvinylchloride.

PACKAGING: Standard Carton - 100 pieces

PRODUCT DESCRIPTION

BULK HARDWARE—Support Brackets

NOTE: *When installing shelves open end to open end or open end to wall, using the labor-saver brackets, Greenfield STRONGLY recommends the use of a #8600 U-Clamp instead of a mounting clip on the wall directly behind the bracket.*

ITEM

DESCRIPTION

8609



9" LABOR-SAVER BRACKET. Main support of 9" Linen shelf when installation is open end to open end, open end to wall, or when shelf is over 3 to 4 feet long. Special feature of the bracket is the elimination of the joiner plate to attach bracket to shelf, making installation quicker. Use one bracket for every 3 to 4 feet of shelving installed. Drill $\frac{7}{32}$ " hole for drywall or $\frac{1}{4}$ " for masonry.

Stamped from 16 gauge steel stock; coated with polyvinylchloride.

ACCESSORIES NEEDED: 1 - #8100 Screw OR 1 - #8210W,
1 - #8200 Anchor Pin-Loaded Anchor

PACKAGING: Standard Carton - 100 pieces

8612

12" LABOR-SAVER BRACKET. Main support of 12" Linen, 12" Rod shelf, and 16" Rod shelf when installation is open end to open end, open end to wall, or when shelf is over 3 to 4 feet long. Special feature of the bracket is the elimination of the joiner plate to attach bracket to shelf, making installation quicker. Use one bracket for every 3 to 4 feet of shelving installed. Drill $\frac{7}{32}$ " hole for drywall $\frac{1}{4}$ " for masonry.

Stamped from 16 gauge steel stock; coated with polyvinylchloride.

ACCESSORIES NEEDED: 1 - #8100 Screw OR 1 - #8210W,
1 - #8200 Anchor Pin-Loaded Anchor

PACKAGING: Standard Carton - 100 pieces

8616

16" LABOR-SAVER BRACKET. Main support of 16" Linen shelf when installation is open end to open end, open end to wall, or when shelf is over 3 to 4 feet long. Special feature of bracket is the elimination of joiner plate to attach bracket to shelf, making installation quicker. Use one bracket for every 3 to 4 feet of shelving installed. Drill $\frac{7}{32}$ " hole for drywall; $\frac{1}{4}$ " for masonry.

Stamped from 16 gauge steel stock; coated with polyvinylchloride.

ACCESSORIES NEEDED: 1 - #8100 Screw OR 1 - #8210W,
1 - #8200 Anchor Pin-Loaded Anchor

PACKAGING: Standard Carton - 100 pieces

8620

20" LABOR-SAVER BRACKET. Main support of 20" Linen shelf when installation is open end to open end, open end to wall, or when shelf is over 3 to 4 feet long. Special feature of bracket is the elimination of joiner plate to attach bracket to shelf, making installation quicker. Use one bracket for every 3 to 4 feet of shelving installed. Drill $\frac{7}{32}$ " hole for drywall; $\frac{1}{4}$ " for masonry.

Stamped from 16 gauge steel stock; coated with polyvinylchloride.

ACCESSORIES NEEDED: 1 - #8100 Screw OR 1 - #8210W,
1 - #8200 Anchor Pin-Loaded Anchor

PACKAGING: Standard Carton - 100 pieces

PRODUCT DESCRIPTION

BULK HARDWARE

ITEM

DESCRIPTION

8030



SHOE RACK SUPPORT BRACKET-PLASTIC. Main front support of shoe rack shelf.

Bracket is not designed to be used with High Bar Rod Shelf.

Use one for every 4 feet of shelving. Molded from hi-tensile plastic.

PACKAGING: Standard Carton - 100 pieces

8048



END BRACKET, ALL-PURPOSE. Side support of shelf when installing to the wall.

Special features include two holes at the top of the end bracket and additional depth in the "U" to accommodate high bar shelving. Molded from hi-tensile plastic.

ACCESSORIES NEEDED: 2 - #8100 Screws

2 - #8200 Anchors

Drill $\frac{7}{32}$ " hole for drywall; $\frac{1}{4}$ " for masonry.

PACKAGING: Standard Carton - 300 pieces

8050

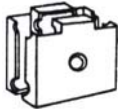

JOINER PLATE. Used to attach support brackets to the front of linen shelf.

Used singly or in pairs. Also used to connect two sections of shelving.

Molded from hi-tensile plastic.

ACCESSORIES NEEDED: 1 - #8300 Bolt

1 - #8400 Hex Nut

PACKAGING: Standard Carton - 1,000 pieces

8055

JOINER PLATE - HIGH BAR. Used to attached support brackets to high

bar shelving in the same manner as #8050.

Molded from hi-tensile plastic.

ACCESSORIES NEEDED: 1 - #8300 Bolt

1 - #8400 Hex Nut

PACKAGING: Standard Carton - 500 pieces

8060



MOUNTING CLIP WITH ANCHOR. One-piece "J" clip with back anchor:

used to support and mount back of shelf to wall. Design of the clip eliminates the need for a down clip. Use one clip every 12 inches.

Molded from Hi-tensile plastic.

ACCESSORIES NEEDED: 1 - #8100 Screw

Drill $\frac{7}{32}$ " hole for dry wall; $\frac{1}{4}$ " for masonry.

PACKAGING: Standard Carton - 1,500 pieces

Master Carton - 6,000 pieces

PRODUCT DESCRIPTION

BULK HARDWARE

ITEM

DESCRIPTION

8065



MOUNTING CLIP WITHOUT ANCHOR. One-piece "J" clip without back anchor; used to support and mount back of shelf to wall. Also used with #8110 pole screw to attached from of shelf to closet pole. Used one clip every 12" for shelf installation. Molded from hi-tensile plastic. Drill $\frac{7}{32}$ " hole for dry wall; $\frac{1}{4}$ " for masonry
ACCESSORIES NEEDED: 1 - #8100 Screw
1 - #8200 Anchor
PACKAGING: Standard Carton - 1,500 pieces
Master Carton - 6,000 pieces

8075



DOWN CLIP. "J" clip without back anchor; used with #8110 pole screw to mount front of shelf to closet poles. Use one clip every 18 inches for shelf installation. Molded from hi-tensile plastic. Drill $\frac{7}{32}$ " hole for dry wall; $\frac{1}{4}$ " for masonry
ACCESSORIES NEEDED: 1 - #8100 Screw
1 - #8200 Anchor
PACKAGING: Standard Carton - 2,000 pieces
Master Carton - 6,000 pieces

8080



END CAP, LARGE. Flexible vinyl cap used to cover cut and/or exposed ends of large long wires of Rod Shelf.
PACKAGING: Standard Carton - 1,000 pieces
Master Carton - 5,000 pieces

8090



END CAP, SMALL. Flexible vinyl cap used to cover cut and/or exposed ends of of all long wires on Linen Shelf and small long wires on Rod Shelf.
PACKAGING: Standard Carton - 1,000 pieces
Master Carton - 10,000 pieces

8100



MOUNTING SCREW. #8 X $1\frac{1}{4}$ " long Phillips pan head mounting screw, zinc plated.
PACKAGING: Standard Carton - 1,000 pieces
Master Carton - 5,000 pieces

PRODUCT DESCRIPTION

BULK HARDWARE

ITEM

DESCRIPTION

8109



WALL SHOE BRACKET. Plastic shoe rack support bracket that attaches to the middle wire of shelf and curves back to rest against the wall. Can be used with all types of shelving except Close-Mesh linen shelf. Useful in tiering shoe racks up a wall.
PACKAGING: Standard Carton - 100 pieces

8110



POLE SCREW. #8 x 1/2" long self-tapping Phillips pan head pole screw, zinc plated. Used to mount "J" clips to closet poles. Use a 1/8" drill bit to drill holes in pole.
PACKAGING: Standard Carton - 1,000 pieces
Master Carton - 5,000 pieces

8133W



END BRACKET. Side support of linen shelf when installing to the wall. Molded from hi-tensile plastic.
ACCESSORIES NEEDED: 2 - #8100 Screws
2 - #8200 Anchors
Drill 7/32" hole for drywall; 1/4" for masonry.
PACKAGING: Standard Carton - 550 pieces

8168



DOUBLE END CAP. One-piece rigid plastic cap for High Bar Rod shelf. Used on cut end of shelf when the end is open with no end bracket to keep hanging rod from sagging. Molded from hi-tensile plastic.
PACKAGING: Standard Carton - 1,000 pieces

8197

DOUBLE END CAP FOR EZ GLIDE ROD SHELF. One-piece steel cap for Easy-Glide rod shelf. Used on cut end of shelf when the end is open with no end brackets to keep hanging rod from sagging. Coated with polyvinylchloride.
PACKAGING: Standard Carton - 100 pieces

8200



ANCHOR. #10-12 x 1" long plastic wall anchor to be used with mounting screw. Drill 7/32" hole for drywall; 1/4" for masonry.
PACKAGING: Standard Carton - 2,000 pieces
Master Carton - 5,000 pieces

8205

ANCHOR (WITHOUT DRIVE NAIL). 1/4" X 1 1/4" white wall anchor to attach labor saver bracket to wall.
PACKAGING: Standard Carton - 1,000 pieces





8210W

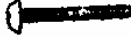

PIN-LOADED ANCHOR. 1/4" x 1 1/4" white wall anchor preloaded with drive nail to attach labor saver bracket to wall.
PACKAGING: Standard Carton - 2,500 pieces
Master Carton - 5,000 pieces

PRODUCT DESCRIPTION

BULK HARDWARE

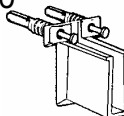
<u>ITEM</u>	<u>DESCRIPTION</u>
8300	 <u>BOLT.</u> 8-32 x 1" long Phillips round head machine bolt, zinc plated. Used with hex nut to install joiner plates. PACKAGING: Standard Carton - 1,000 pieces Master Carton - 5,000 pieces
8400	 <u>HEX NUT.</u> 8-32 hex nut, zinc plated. Used with bolt to install joiner plates. PACKAGING: Standard Carton - 1,000 pieces Master Carton - 5,000 pieces
8500	 <u>TOGLER.</u> Medium toggler; alternative to #8200 anchor. Used for added anchorage. Drill $\frac{7}{32}$ " hole for drywall; $\frac{1}{4}$ " for masonry. PACKAGING: Standard Carton - 1,000 pieces Master Carton - 5,000 pieces
8510	 <u>SETTING KEY.</u> Used to set #8500 toggler in wall by flaring out back wings of the toggler. PACKAGING: Standard Carton - 100 pieces
8600	 <u>U-CLAMP.</u> U-shaped clamps used to support and mount back of shelf to wall; alternative to J-clips. Recommended to be used on wall directly behind labor-saver support brackets. Use one every 12 inches or as needed on labor-saver support brackets. Molded from hi-tensile plastic. ACCESSORIES NEEDED: 2 - #8100 Screws 2 - #8200 Anchors PACKAGING: Standard Carton - 1,000 pieces Master Carton - 5,000 pieces
8650	 <u>PIN-LOADED END BRACKET.</u> Side support of shelf when installing to the wall. Special features: Anchor is molded to the bracket and drive pin is preloaded. Molded of hi-tensile plastic Drill $\frac{7}{32}$ " hole for drywall; $\frac{1}{4}$ " for masonry. PACKAGING: Standard Carton - 200 pieces
8651	<u>END BRACKET WITH ANCHOR.</u> Same as above, without the preloaded drive pin. Molded of hi-tensile plastics. Drill $\frac{7}{32}$ " hole for drywall; $\frac{1}{4}$ " for masonry. PACKAGING: Standard Carton - 250 pieces

PRODUCT DESCRIPTION

BULK HARDWARE

ITEM

DESCRIPTION

8660

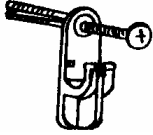

PRELOADED MOUNTING CLIP. One-piece "J" clip with back anchor and preloaded screw; used to support and mounting back of shelf to wall. Design of clip eliminates need for down clip. Use one for every 12 inches for shelving. Molded from hi-tensile plastic.
Drill $\frac{7}{32}$ " hole for drywall; $\frac{1}{4}$ " for masonry.
PACKAGING: Standard Carton - 1,000 pieces
Master Carton - 4,000 pieces

8665

PIN-LOADED MOUNTING CLIP. One-piece "J" mounting clip with back anchor (#8060) and pre-set drive nail; used to support and mount back of shelf to wall. Design of clip eliminates the need for down clip. Use one clip every 12 inches. Drill $\frac{7}{32}$ " hole for drywall; $\frac{1}{4}$ " for masonry. Molded of hi-tensile plastic.
PACKAGING: Standard Carton - 1,000 pieces
Master Carton - 4,000 pieces

8680



HEAVY DUTY MOUNTING CLIP WITH ANCHOR. One-piece "J" clip with back anchor: used to support and mount back of shelf to wall. Design of the clip eliminates the need for a down clip. Use one clip every 12 inches. Molded from Hi-tensile plastic.
ACCESSORIES NEEDED: 1 - #8100 Screw
Drill $\frac{7}{32}$ " hole for dry wall; $\frac{1}{4}$ " for masonry.
PACKAGING: Standard Carton - 1,500 pieces
Master Carton - 5,000 pieces

8685



HEAVY DUTY MOUNTING CLIP WITHOUT ANCHOR. One-piece "J" clip without back anchor; used to support and mount back of shelf to wall. Also used with #8110 pole screw to attached from of shelf to closet pole. Used one clip every 12" for shelf installation. Molded from hi-tensile plastic. Drill $\frac{7}{32}$ " hole for dry wall; $\frac{1}{4}$ " for masonry
ACCESSORIES NEEDED: 1 - #8100 Screw
1 - #8200 Anchor
PACKAGING: Standard Carton - 1,500 pieces
Master Carton - 5,000 pieces

PRODUCT DESCRIPTION

BULK HARDWARE

ITEM

DESCRIPTION

8690



HEAVY DUTY PIN-LOADED MOUNTING CLIP. One-piece "J" mounting clip with back anchor (#8680) and pre-set drive nail; used to support and mount back of shelf to wall. Design of clip eliminates the need for down clip. Use one clip every 12 inches. Drill $\frac{7}{32}$ " hole for drywall; $\frac{1}{4}$ " for masonry. Molded of hi-tensile plastic.

PACKAGING: Standard Carton - 1,000 pieces

Master Carton - 4,000 pieces

8695

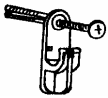

HEAVY DUTY PRELOADED MOUNTING CLIP. One-piece "J" clip with back anchor and preloaded screw; used to support and mounting back of shelf to wall. Design of clip eliminates need for down clip. Use one for every 12 inches for shelving. Molded from hi-tensile plastic.

Drill $\frac{7}{32}$ " hole for drywall' $\frac{1}{4}$ " for masonry.

PACKAGING: Standard Carton - 1,000 pieces

Master Carton - 4,000 pieces

PRODUCT DESCRIPTION

ORGANIZER RACKS

GENERAL INFORMATION:

2-tier, 3-tier, and 4-tier sizes:

Side support wires: 7 gauge steel wire
Basket support wires: 7 gauge steel wire
Basket crosswires: 12.5 gauge steel wire
Resistant-welded
Coated with polyvinylchloride

8-tier sizes:

Side support wires: 4.5 gauge steel wire
Basket support wires: 7 gauge steel wire
Basket crosswires: 12.5 gauge steel wire
Resistant-welded
Coated with polyvinylchloride

HARDWARE INCLUDED -- ALL SIZES:

6 - #8075 Down clips
6 - #8100 Screws
6 - #8200 Anchors

DIMENSIONS OF ORGANIZER RACKS



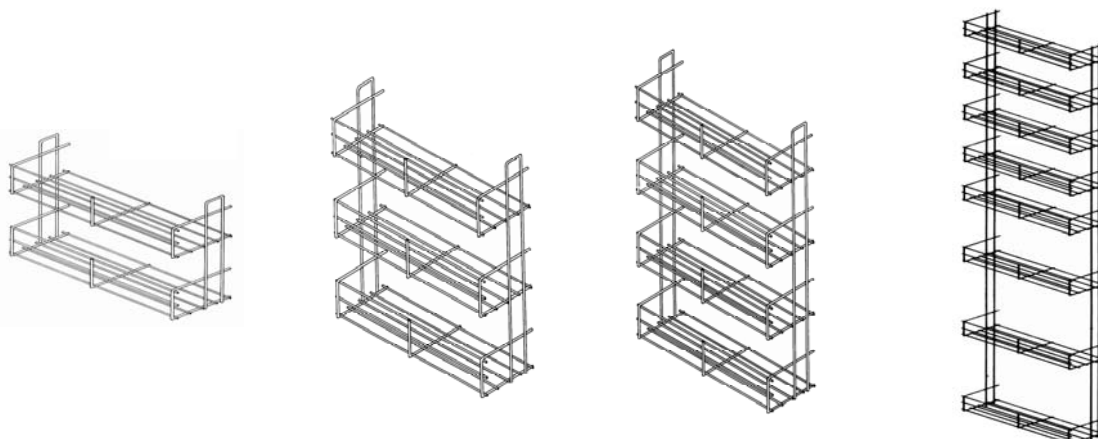

(Organizer rack baskets measure 4¹/₄" deep front to back)

3212	2-tier x 12" wide x 11 ¹ / ₂ " high x 4 ¹ / ₄ " deep	18 pieces/carton
3218	2-tier x 18" wide x 11 ¹ / ₂ " high x 4 ¹ / ₄ " deep	10 pieces/carton
3312	3-tier x 12" wide x 23" high x 4 ¹ / ₄ " deep	12 pieces/carton
3318	3-tier x 18" wide x 23" high x 4 ¹ / ₄ " deep	8 pieces/carton
3412	4-tier x 12" wide x 29 ⁵ / ₈ " high x 4 ¹ / ₄ " deep	6 pieces/carton
3418	4-tier x 18" wide x 29 ⁵ / ₈ " high x 4 ¹ / ₄ " deep	4 pieces/carton
3812	8-tier x 12" wide x 72" high x 4 ¹ / ₄ " deep	2 pieces/carton
3818	8-tier x 12" wide x 72" high x 4 ¹ / ₄ " deep	2 pieces/carton









PRODUCT DESCRIPTION

ACCESSORIES AND HARDWARE KITS

<u>ITEM</u>	<u>DESCRIPTION</u>
3900	 <p><u>21-PAIR DOOR/WALL SHOE RACK.</u> One-piece shoe rack unit constructed of 7 gauge and 12.5 gauge steel wire. Resistant-welded; coated with polyvinylchloride. Rack attached to door or wall as desired. All hardware is attached to the unit. DIMENSIONS: 65" high x 5¹/₂" deep x 24¹/₄" wide PACKAGING: Standard Carton - 2 pieces</p>
9000	 <p><u>UTILITY RACK WITH HARDWARE.</u> 16" long all-purpose rack with four (4) J-hooks. Mounting hardware attached: 3 - #8060 Mounting Clips with anchor; 3 - #8100 Screws. Constructed from 1.5 gauge steel wire, resistant-welded. Coated with polyvinylchloride. PACKAGING: Standard Carton - 10 pieces</p>
9100	 <p><u>CORNER SHELF WITH HARDWARE.</u> Wire corner storage shelf. Shelf dimensions: 24" wide across front lip 17" along sides Mounting hardware attached: 4 - #8060 Mounting clips w/anchor 2 - #8075 Down clips 6 - #8100 Screws 2 - #8200 Anchors Support wires: 7 gauge steel wire Crosswires: 12.5 gauge steel wire Resistant-welded; coated with polyvinylchloride. PACKAGING: Standard Carton - 10 pieces</p>
9200	 <p><u>67" CLOSET POLE.</u> 1/2 x 1/2 x 67" long steel pole, painted white. Used to support front of shelf when tiering shelves. ACCESSORIES NEEDED: 2 - #9400 Pole caps; #8075 Down clips <u>OR</u> #8065 Mounting clips w/o anchor and #8110 Pole screws. The number of clips and screws to be used is determined by the number of shelves to be installed. EXAMPLE: If installing 4 shelves, use 4 clips and 4 screws per pole. PACKAGING: Standard Carton - 25 pieces</p>
9300	 <p><u>84" CLOSET POLE.</u> 1/2 x 1/2 x 84" long steel pole, painted white. Used to support front of shelf when tiering shelves. ACCESSORIES NEEDED: 2 - #9400 Pole caps; #8075 Down clips <u>OR</u> #8065 Mounting clips w/o anchor and #8110 Pole screws. The number of clip and screws to be used is determined by the number of shelves to be installed. EXAMPLE: If installing 4 shelves, use 4 clips and 4 screws per pole. PACKAGING: Standard Carton - 25 pieces</p>

PRODUCT DESCRIPTION

ACCESSORIES AND HARDWARE KITS

<u>ITEM</u>	<u>DESCRIPTION</u>
9315	<p><u>POLE HARDWARE KIT.</u> Convenient packaging of mounting hardware for installation of closet poles.</p> <p>HARDWARE INCLUDED:</p> <ul style="list-style-type: none">4 - #8065 Mounting clips w/o anchor4 - #8100 Pole Screws2 - #9400 Pole caps <p>PACKAGING: Standard Carton - 25 Kits</p>
9342	 <p><u>42" CLOSET POLE.</u> $1/2 \times 1/2 \times 42$" long steel pole, painted white. Used to support the front of the shelf when tiering shelves. Can be used with #9415 Pole connector to form 84" long closet pole.</p> <p>ACCESSORIES NEEDED: 2 - #9400 Pole Caps; 1 - #9415 Pole Connector; #8075 Down clips <u>OR</u> #8065 Mounting clips w/o anchor; #8110 Pole screws. The number of clips and screws needed is determined by the number of shelves to be installed.</p> <p>PACKAGING: Standard Carton - 25 pieces</p>
9400	 <p><u>POLE CAP.</u> Flexible vinyl cap, $1/2$" square x $1/2$" long, used to cover the ends of poles. Use two for every pole.</p> <p>PACKAGING: Standard Carton - 100 pieces</p>
9415	 <p><u>POLE CONNECTOR.</u> Molded hi-tensile plastic connector used to join two pieces of pole to form one unit.</p>
9416	 <p><u>DRIVE NAIL.</u> Steel drive nail to be used with #8060, #8680, and #8651.</p> <p>PACKAGING: Standard Carton - 1000 pieces</p>
9420	 <p><u>F-MOLD.</u> "F" -shaped channel mold to be used with shelving in oddly shaped closets or corners. Molded of hi-tensile plastic.</p> <p>PACKAGING: Standard Carton - 50 pieces</p>
9450	 <p><u>TOUCH-UP PAINT KIT.</u> Vinyl patch compound used to patch vinyl coating on shelving, brackets, and other coated products. $1/2$ pint can with brush top.</p>

PRODUCT DESCRIPTION

ACCESSORIES

ITEM

DESCRIPTION

9720



12" EZ GLIDE ROD CORNER CONNECTOR. Used with 12" Easy-Glide Shelving to

create a rounded corner in an L-shaped or U-shaped closet.

DIMENSIONS: 19" deep from back corner to front
19" along sides

Deck Wires: 12.5 gauge steel wire

Crosswires: 4.5 gauge steel wire

Front Wires: 1.5 gauge steel wire

Hanging Rod: 1.5 gauge steel wire

J-Shaped Connecting Support: 12 gauge steel, stamped

Resistant welded; coated with polyvinylchloride

INSTALLATION HARDWARE INCLUDED:

2 - #8060 Mounting clips w/anchor

2 - #8600 U-Clamps

6 - #8100 Screws

4 - #8200 Anchors

PACKAGING: Standard Carton - 2 pieces

9755



16" EZ GLIDE ROD CORNER CONNECTOR. Used with 16" Easy-Glide Shelving to

create a rounded corner in an L-shaped or U-shaped closet.

DIMENSIONS: 19" deep from back corner to front
19" along sides

Deck Wires: 12.5 gauge steel wire

Crosswire: 4.5 gauge steel wire

Front Wires: 1.5 gauge steel wire

Hanging Rod: 1.5 gauge steel wire

J-Shaped Connecting Support: 12 gauge steel, stamped

Resistant welded; coated with polyvinylchloride

INSTALLATION HARDWARE INCLUDED:

2 - #8060 Mounting clips w/anchor

2 - #8600 U-Clamps

6 - #8100 Screws

4 - #8200 Anchors

PACKAGING: Standard Carton - 2 pieces

PRODUCT DESCRIPTION

ACCESSORIES

ITEM

DESCRIPTION

9850



12" CORNER CONNECTOR SHELF, HIGH BAR. Used with 12" Rod Shelf, High Bar, to create a rounded corner in a L-shaped or U-shaped closet. DIMENSIONS: 18" deep from back corner to front.

18" along sides

1¹/₄" space between shelf and hanging rod.

Deck wires: 12.5 gauge steel wire

Crosswires: 4.5 gauge steel wire

Front wire and Hanging Rod: 1.5 gauge steel wire

Resistant welded; coated with polyvinylchloride

INSTALLATION HARDWARE INCLUDED:

4 - #8055 Joiner plates, high bar

4 - #8060 Mounting clips w/anchor

4 - #8100 Screws

2 - #8300 Bolts

2 - #8400 Hex nuts

PACKAGING: Standard Carton - 6 pieces

9855



16" CORNER CONNECTOR SHELF, HIGH BAR. Used with 16" Rod Shelf, High Bar, to create a rounded corner in a L-shaped or U-shaped closet. DIMENSIONS: 18" deep from back corner to front.

18" along sides

1¹/₄" space between shelf and hanging rod.

Deck wires: 12.5 gauge steel wire

Crosswires: 4.5 gauge steel wire

Front wire and Hanging Rod: 1.5 gauge steel wire

Resistant welded; coated with polyvinylchloride

INSTALLATION HARDWARE INCLUDED:

4 - #8055 Joiner plates, high bar

4 - #8060 Mounting clips w/anchor

4 - #8100 Screws

2 - #8300 Bolts

2 - #8400 Hex nuts

PACKAGING: Standard Carton - 6 pieces

PRODUCT DESCRIPTION

ACCESSORIES

ITEM

DESCRIPTION

9610

TOP ADJUSTMENT INSTALTION TEMPLATE. Installation template used to quickly install shelving. Height can be adjusted using the top adjusting bracket. Constructed of aluminum.

